

Connector Specification

CXB210-EFWA

Cable-to-board | 2PIN | 10mm Board width | EF Protection



【Features】

- Name: Cable-to-board connector
- PIN: 2PIN
- Process: EF
- Applicable board width: 10 mm
- Rated current: AWG 20 / 6A Max ; AWG 22 / 4A Max
- Rated voltage: 5V / 9V / 12V / 18V / 24V / 36V / 48V ;
- Voltage tolerance: 500 V;
- Temperature tolerance: 80 ℃ ;
- Working temperature: - 20 ℃ ~ + 80 ℃ ;
- Acceptable humidity: 15% ~ 90%;
- 2-year warranty;
- Applicable product: 2216 LED Strip: whole series (excluding models with double-row LEDs)
2835 LED Strip: less than 196leds/m (not include 196leds/m)
5050 LED Strip: less than 60leds/m (include 60leds/m)
FD: whole series



【Mechanical Parameter】

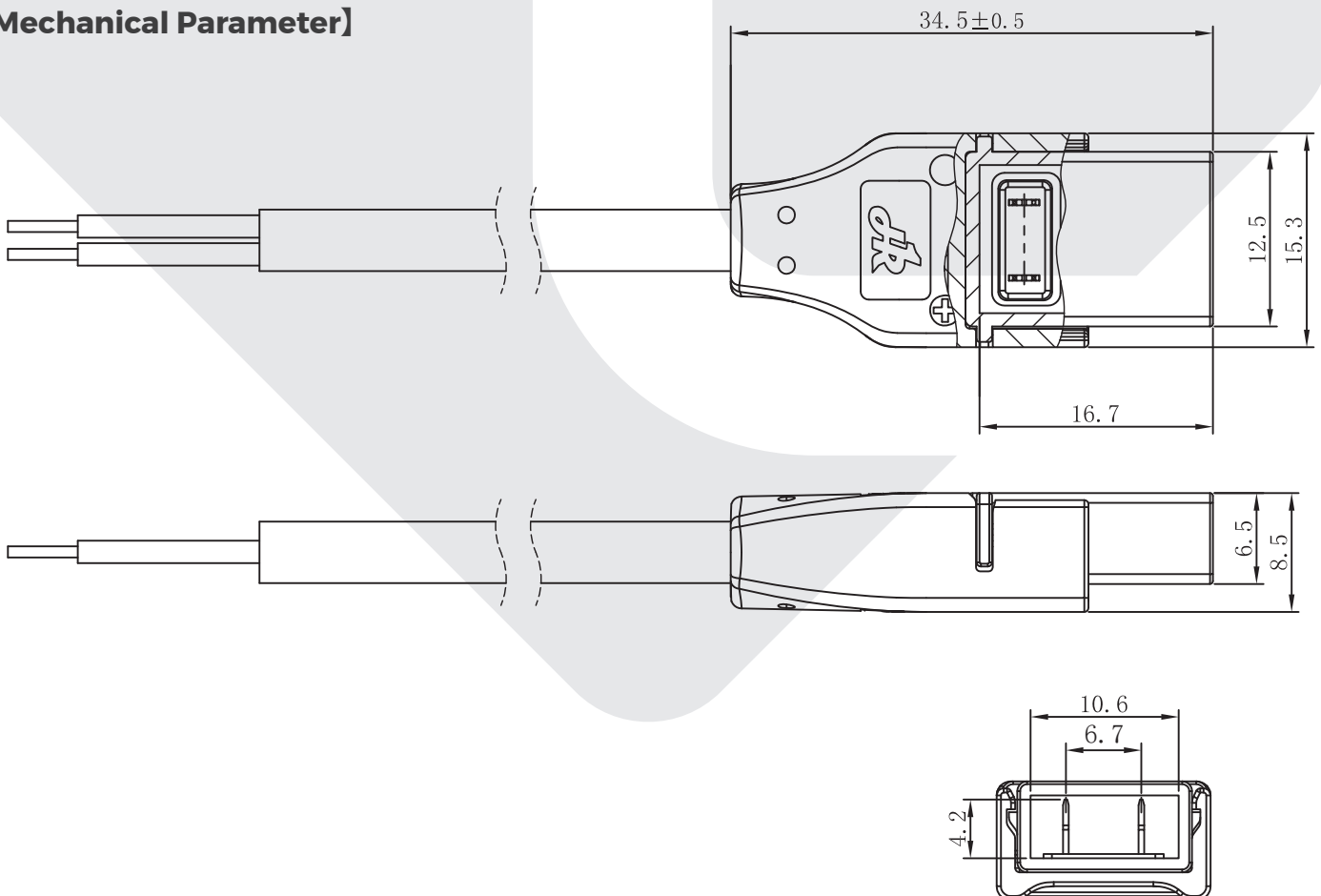

[Installation]

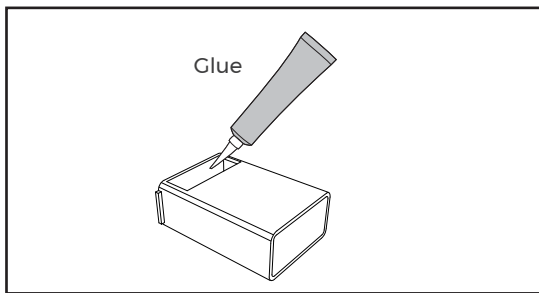

1. Drip appropriate amount of glue in the slot of the crystal buckle.

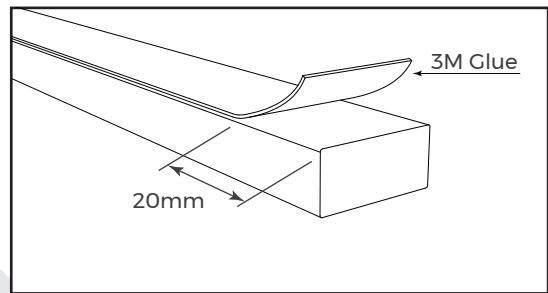

2. Tear off 3M adhesive at the connection end for about 20mm, and clean the adhesive surface of LED strip.

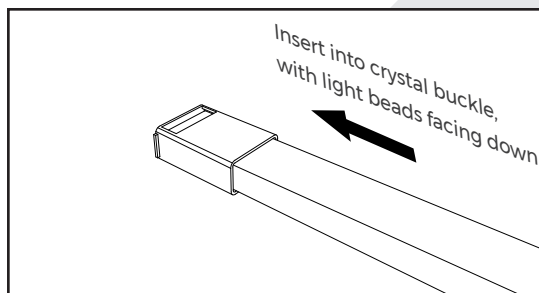

3. As diagram shows, insert one end of protective led strips (light beads facing down) into crystal buckle until it reaches the bottom. Pay attention to positive and negative poles.

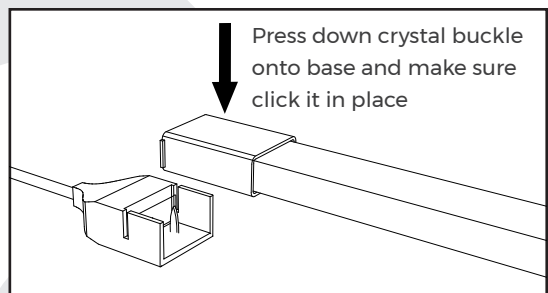

4. Hold crystal buckle with its slot upside down, then use flat plier or other professional tools to snap it onto base. Check if the metal pieces of the base is in contact with the positive and negative poles of LEDs to avoid short circuit.

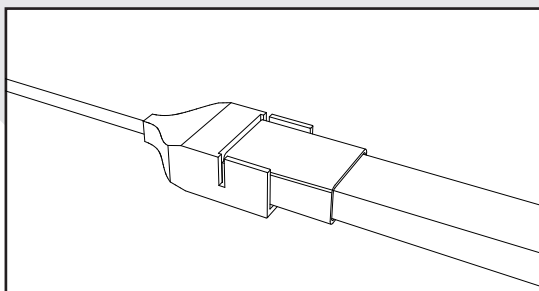

5. Installation finishes.

【Product package】

· Standard package information (1 Set/bag)

1. 1 Set connector packed into PE bag.

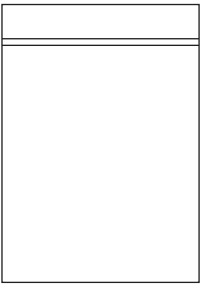

2. 5 PE bags packed into box



3. Stick information label onto the box

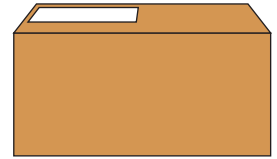

Model	Net weight per piece	Weight of per bag	Weight of per box	Weight of per carton
CXB210-EFWA	12g	13g	82g	4.87Kg

Note: weight error is within 10%

【Precaution】

1. Please use this product in dry environment.
2. Before installation, pay attention to negative and positive poles of LED strip to avoid short circuit or product damage.
3. Use professional tools as per requirements to press down metal head of connector to avoid hurt or fingers or product damage.